



# Understanding The Versadjust Patent and Patent Improvements Pending

The Versadjust, adjustable V-Series line reaches heights from 2 ¼ inches to 36 inches, has a 1250 pound (FS3) weight bearing capacity and contains built in slope compensation from 0 – one half inch per foot slope. Precise spacer tabs allow for deck drainage, and the screw-to-adjust height setting assures a perfectly straight and level deck. The Bison Versadjust pedestal has a broad footprint that provides stability, is impervious to freeze thaw cycles, and offers a range of heights suited to almost any application. Made in the USA.

Versadjust Quick Clip Coupler © (patent pending) increases the speed and efficiency installing pedestals at heights over 9 inches. Accessories are available to compensate for additional slope and accommodate heights from 1/8 inch to 2 ¼ inches.

Use of Versadjust Pedestals with Bison Brace System for Excess Height Installations from 24"-36" in height or for installations requiring additional stability.

### V Tab

Specify 1/8" or 3/16"  
Place Spacer Tab on top of pedestal.  
To remove tabs:  
strike with hammer from above

### V Top

Comes screwed into V Base Unit.  
Unscrew top until indicator bumps are felt and heard. DO NOT extend beyond bumps EXCEPT to add a VC2 Coupler to Model V4.

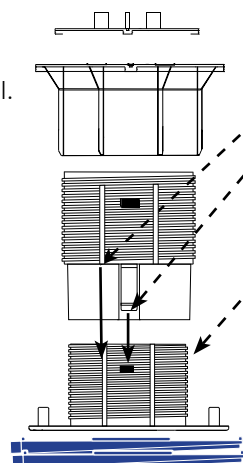

### VC2 Coupler (Works with Model V4 Only)

To Assemble:  
Align lines on coupler and base  
Align tab with Quick Connect slot.  
Slide together until tab locks into place.

To Separate:  
Hook C2 Coupler Release Tool into slots on the side of the coupler, detach tool & pull apart.

### V Base

Comes screwed into V Top Unit. Unscrew top until Thread indicators are felt and heard. DO NOT extend beyond indicators EXCEPT to add an VC2 Coupler to Model V4.

### VB Leveller Base

Built-in base 0 - ½" (4%) slope compensation.

## Built In Slope Base Compensation

Each V-Series pedestal comes with base slope compensation for up to 1/2" per foot (4%) slope.

Slope Adjustment:  
Point each finger tab downhill for 1/2" per foot (4%) slope.  
Rotate base pieces for precise slope compensation.

To Create a Flat Base:  
Position finger tabs opposite one another.

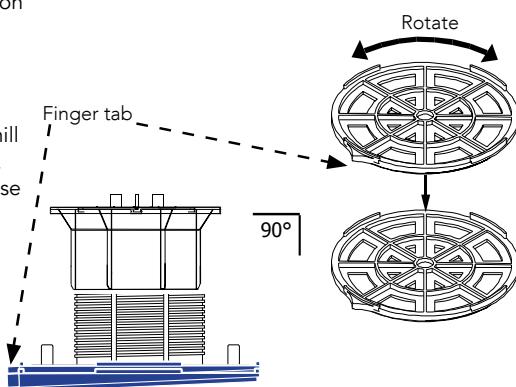

To Remove VB Base Leveller:  
Slide pedestal base out of VB base leveller

For additional slope compensation:  
A maximum of two (2) Model LD4 base levellers can be used with the V-Series adding an additional 1/2" per foot (4%) slope for a total of 1 inch per foot (0-8%) slope. Each LD4 adds an 3/8" to the overall height of the pedestal.

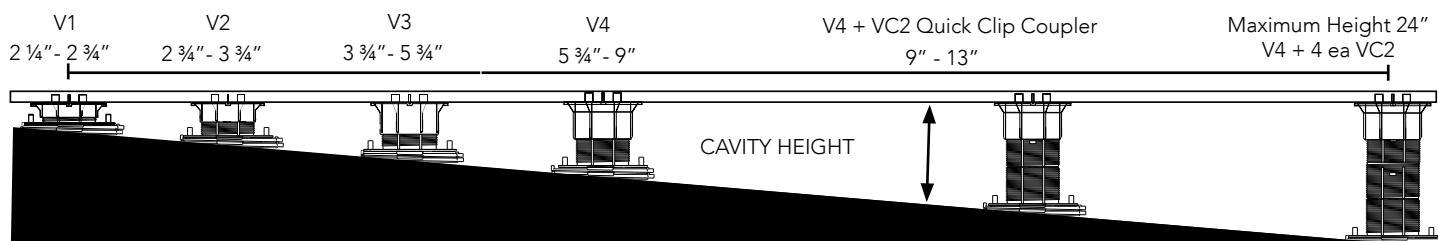

Copyright 5-1-2013 United Construction Products, Inc. All Rights Reserved

**VERSADJUST**

Adjustable Deck Supports

Installation Details

February 2015

# Advanced Layout and Pedestal Placement

Acronym	Definition
LP	Low Point
HP	High Point
RD	Roof Drain

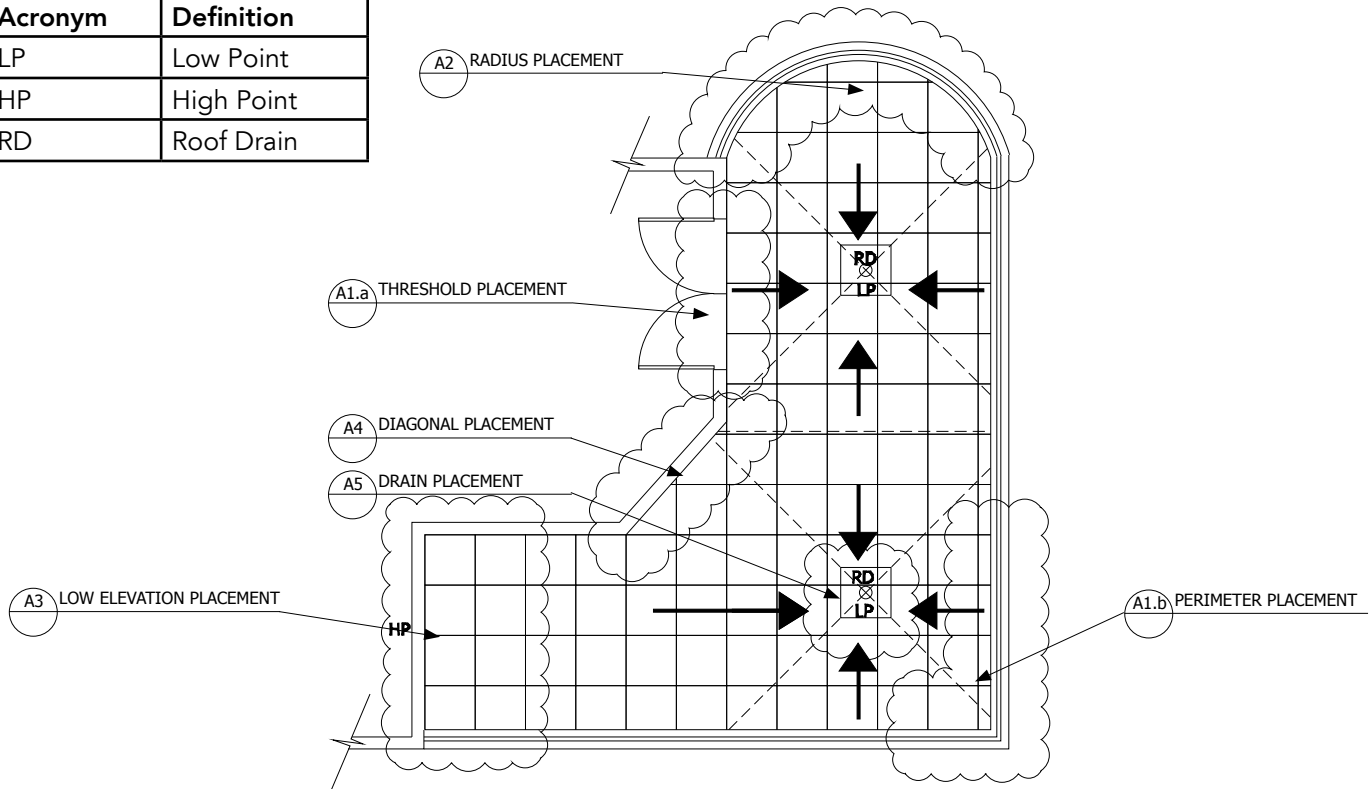

## "T" Method Installation

1. Determine cavity height at all thresholds, drains and high points.
2. Deduct thickness of decking material.
3. Mark top of pedestal elevation around deck with laser level
4. Plan paver/pedestal layout pattern
5. Install "T" shaped portion of deck starting from threshold or high point
6. Adjust to correct height and level.
7. Installation on both sides of the "T" can proceed.

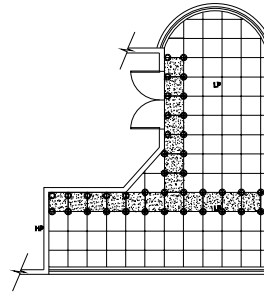

## Determining Cavity Height

- The cavity height is the space between the top of the roofing membrane, and the bottom of the decking material.
- Use of a laser level or chalk line may assist.
- Also refer to the detachable measuring device printed on the box.

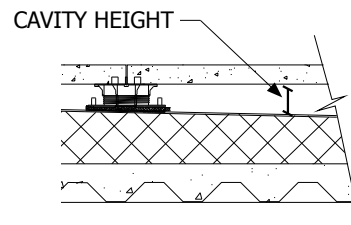

## A1 (a) Threshold and (b) Perimeter Placement

- Remove tabs as necessary to inset edge pedestals.
- Turn pedestal upside-down or trim the base for tight fits.
- Never allow more than 1/8" width between the decking material and edge containment.
- Tabs may be adhered into place with construction adhesive to ensure spacing when "normal" tab placement is not possible.

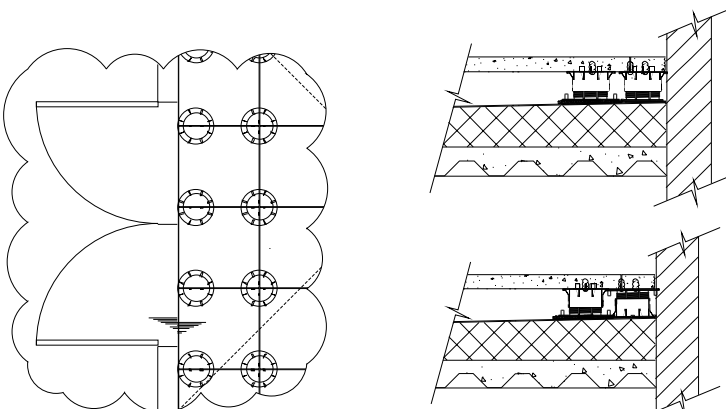

## A2 Radius Placement

- Use extra pedestals under triangular pieces to support small pieces.
- Never allow more than 1/8" width between the decking material and edge containment.
- Add an extra pedestal at perimeter bends.
- Remove extra tabs to inset pedestals.
- Adhere small pavers to top of pedestal with construction adhesive.
- Turn pedestal upside-down or trim pedestal base as needed to fit around perimeter.
- Use removed tabs to maintain spacing between pavers.

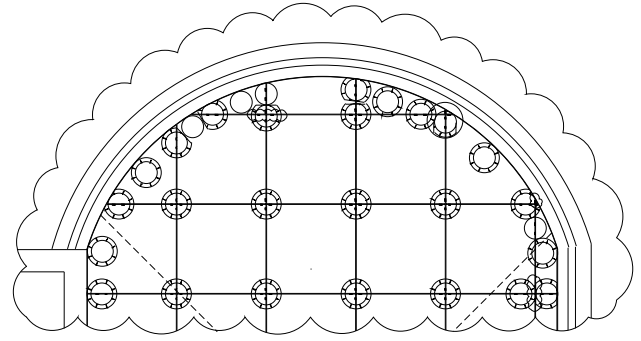
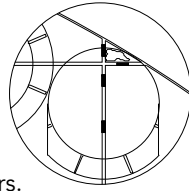

## A3 Low Elevation Placement

For low elevations the following pedestals are available:

### LOW HEIGHT PEDESTALS

Model:		Height:
VT18 or VT316	●	1/8"
HD25-18 or HD25-316	○	1/4"
HD50-18 or HD50-316	●	1/2"
HD75-18 or HD75-316	⊗	3/4"
LO-18 or LO-316	⊗	1 1/4 - 2"

Shims can also be used to accommodate variations in height, in either 1/8" (PS1) or 1/16" (B11) increments.

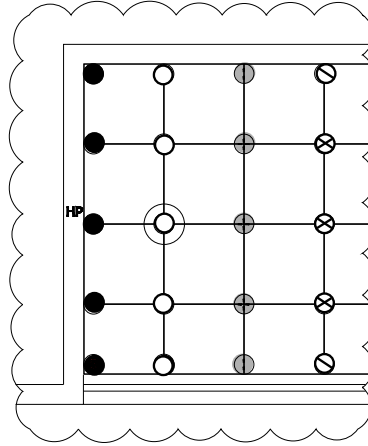

## A4 Diagonal Placement

- Use extra pedestals under triangular pieces to support small pieces.
- Never allow more than 1/8" width between the decking material and edge containment.
- Remove extra tabs to inset pedestals.
- Adhere small pavers to top of pedestal with construction adhesive.
- Trim pedestal base as needed to fit around perimeter.
- Use removed tabs to maintain spacing between pavers.

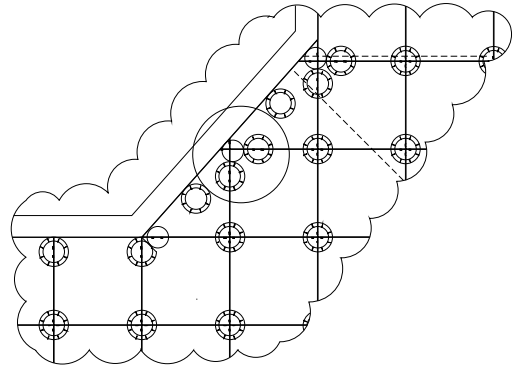
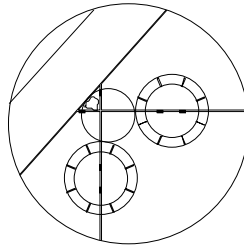

## A5 Drain Placement

- Elevate a steel plate or paver above the drain, but below the deck itself.
- Use that elevated plate or paver to support a pedestal where you need for the deck above.

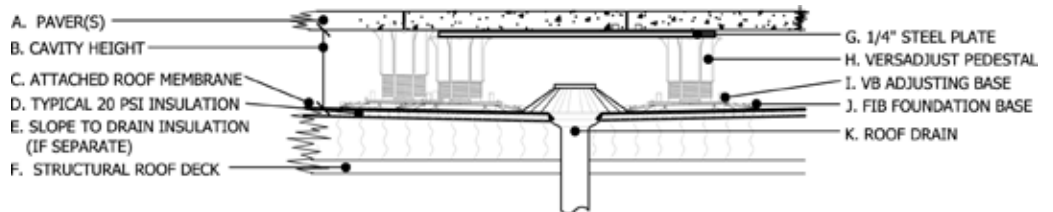
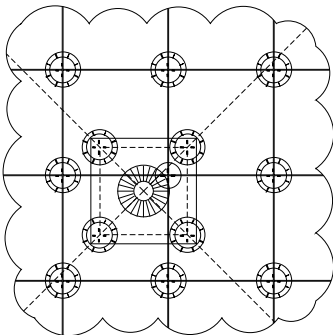

# Working with Wood

## JT Wood Joist Top

Center Joist Top on BISON Pedestal. Using a screwdriver, insert Bison Screw (provided) into the hole in the center of the Joist Top & hand tighten to attach. Works both with 2 x and 4 x lumber. Attach joist to Joist Top using #8 Deck Screws (NOT provided)

**IMPORTANT:** When attaching to the pedestal - DO NOT OVER-TIGHTEN SCREW

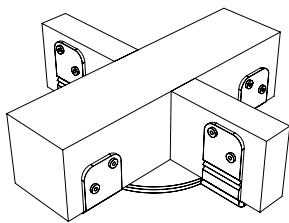

As Shown Above Joist Top with 2x and 4x Joists.

## FS-1 Wood Tile Fastening Kit

Place washer between the bottom rail of the tile and the upper slat. Screw FS1 screw through the FS1 washer, into center hole of spacer tabs and into pedestal.

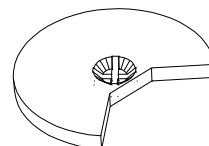

Make sure that washer clamps all corners of wood tiles and then tighten. To remove a wood tile: Loosen screw and using screwdriver, rotate washer to release wood tile.

# Working with Shims

## B-11 (1/16") or PS-1 (1/8") Shims

B11's or PS1s may be placed on top of pedestals to accommodate for minor leveling of pavers with thickness variations. Use no more than 2 shims. If using only 1/4 segment, adhere it to the pedestal with construction adhesive.

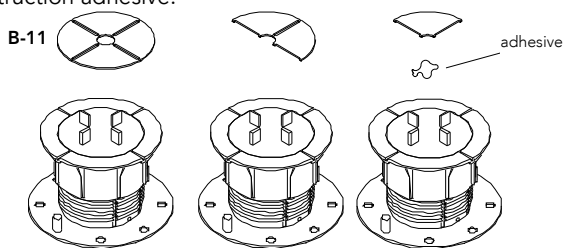

## Shims Under Pedestals

Place shims (whole or in segments) under the pedestal in a stairstep fashion to compensate for sloping substrates.

- Use only B11 shims for this application.
- Use no more than four (4) shims.

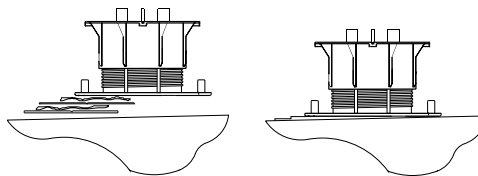

# Pedestal Base Pads

## Floating Insulation Base (FIB)

If common roof insulation is installed immediately below the membrane, the type and density of the insulation is of utmost importance. For roofing systems having "common" insulations with a medium density of 20 psi Bison recommends using the Bison Floating Insulation Base (FIB). FIBs are installed immediately below the Bison Deck Support pedestals to disperse the deck load. Please refer to specifications for proper use.

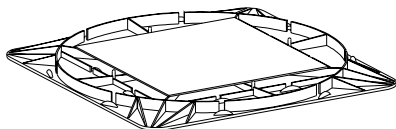

## Floating Foundation Base (FFB)

Bison Floating Foundation Bases (FFB) are recommended for use beneath all on grade Bison Deck Support decks. Level the surface and set directly on grade as a base.

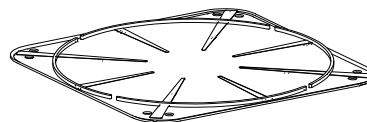

# Maintenance Guide

Routine maintenance of your paver deck system will enhance the beauty, reduce major repairs, and prolong the life of your deck. Below is a list of maintenance guidelines that should be performed on a regular basis:

1. Check for "rocking" pavers. If you notice pavers rocking back and forth while walking on the deck simply lift paver up and shim 1 or more corners until paver is level on all four corners. To ensure pedestal stability, make sure "indicator bumps" are engaged. Bison B11 (1/16") or PS1 (1/8") shims can be ordered and shipped.
2. Depending on substrate materials some settling and or deflection can occur. Remove paver and adjust the pedestal until level height is achieved. You may need to do this on more than one pedestal to level out an area.
3. Clean drains and scuppers on a regular basis. Water should completely drain off roof deck within 48 hours after rainfall, under ambient drying conditions. Standing or "ponding" water can be detrimental to some waterproofing systems.
4. Periodically check spacer tabs between pavers and replace broken spacer tabs immediately. Loss of spacer tabs can cause unsafe deck movement.
5. Make sure the edge restraint remains intact. There should not be room around perimeters of the deck in excess of 1/8" width which could cause lateral movement of pavers, and create an unsafe condition.
6. Follow paver manufacturers' suggestions for upkeep and maintenance of pavers.